

Impulse wrenches

Application and impulse mechanism



DOBCO
EQUIPMENT LTD

Ontario's Largest
Pneumatic & Hydraulic Tool Distributor

1-2430 Lucknow Drive, Mississauga, Ontario L5S 1V3. Tel: 905-672-5557 Fax: 905-672-5559
Email: sales@dobcoeqp.com www.dobcoeqp.com



Faster tools make assembly quicker

Yokota impulse wrenches are widely used for tightening jobs in the assembly industry, where accurate torque tolerances are necessary. Impulse tools are light, powerful, small and very importantly, have no kick-back. The Yokota range of impulse tools is increasing fast, starting at 6Nm to tighten small joints, and goes up to 600Nm. Evaluation of tightening processes in car assembly shows that tightening joints uses 10% of the total assembly time. Working with faster tools therefore can speed up assembly lines substantially.

A fail-safe system

Product liability is essential to carmakers. All tightened joints have to be correct. For this reason all bolted joints must be counted, documented and, of course, tightened with the right clamping force. In order to do this, you need an impulse wrench (with a built-in transducer) connected to a controller. If the controller establishes that the tightened joints do not meet the specifications, it can give a line-stop signal and the joints have to be checked manually. This fail-safe system fits perfectly in the *Poka Yoke strategy*.

High repeatability

Impulse wrenches have a twin blade impulse mechanism for sealing oil which gives a high repeatability. The mechanism is designed so that the liner, rotated by the air motor gives an equal torque on both blades and instant rotation torque on the mainshaft (see figure below, number 1-8). A by-pass is designed in the liner so that the oil can escape from the area of high pressure to the area of low pressure at the moment of creating a pulse and the amount of oil flow can be adjusted by the relief valve to control the torque output. Depending on model and setting, the impulse wrenches give 10 - 40 impulses per second. The power is transmitted by oil pressure and therefore the impulse wrenches have a very low noise- and vibration level.

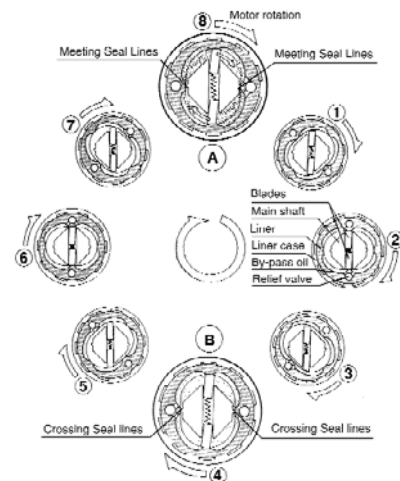

Impulse wrenches

New series

Double chamber air motor, light weight design



Type	Square/ Hex drive	Bolt capacity mm	Revolutions p/min	Torque Nm*	Air consumption l/sec	Weight kg	Inlet- thread	Hose diameter mm	Dimensions	
									A mm	B mm
YLa70A	1/4" Hex	6-8	7.000	20-28	5.5	0.8	PT 1/4"	6.5	132	22
YLa80A	1/4" Hex	8	7.000	24-35	5.8	0.9	PT 1/4"	6.5	139	22
YLa70E	3/8" Square	6-8	7.000	20-35	5.5	0.8	PT 1/4"	6.5	132	22
YLa80E	3/8" Square	8	7.000	33-50	5.8	0.9	PT 1/4"	6.5	139	22
YLa90E	3/8" Square	8-10	6.500	47-70	6.7	1.0	PT 1/4"	9.5	148	24
YLa110E	1/2" Square	10-12	6.000	65-105	9.6	1.4	PT 1/4"	9.5	164	26

Also available in system wrench execution (see page 16)

TKa 70A	1/4" Hex	6-8	7.000	20-27	5.5	1.3	PT 1/4"	6.5	179	22
TKa 70	3/8" Square	6-8	7.000	20-35	5.5	1.3	PT 1/4"	6.5	179	22
TKa 90	3/8" Square	8-10	6.500	47-70	6.7	1.5	PT 1/4"	9.5	195	24
TKa 110	1/2" Square	10-12	6.000	65-105	9.6	1.9	PT 1/4"	9.5	210	26
TKa 120	1/2" Square	12	5.900	85-130	10	2.4	PT 1/4"	9.5	223	28
TKa 140	1/2" Square	14	5.200	100-160	13	2.9	PT 1/4"	9.5	235	30

- No lube air motor to protect the environment
- Extended oil change intervals due to new impulse mechanism design
- Low weight of tool
- Low air consumption, high efficiency air motor
- High durability, due to improved air motor design features with special air motor vanes (pat.pend).
- Improved ergonomic design
- Low noise and vibration level
- Low trigger-force

* Torque specifications:

All specified torques are measured on the Yokota testers, series YET, at a dynamic airpressure of 0.59Mpa. The Yokota testers have a static transducer, the specified torques are therefore to be used as a guidance only. In general the torque range will be lower in case of using: lower airpressure, extension bars, torx or hexagon inset sockets, soft joints, etc.



YEX-150S Crowfoot



Special application
Y-70E with Crowfoot

You will find accessories for impulse wrenches on pages 18 - 20.

Tailor-made tools!

Please inform us about your application specifications so we can make you a suitable proposal.

Impulse wrenches

Double chamber air motor



Y-41A
Y-46E/A
Y-56E/A
Y-61E/A



Y-70
Y-90E



Y-100E
Y-130E
Y-140

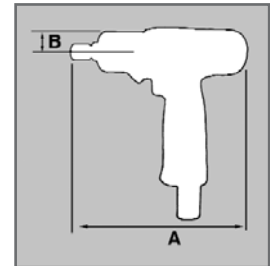

Type	Square/ Hex drive	Bolt capacity mm	Revolutions p/min	Torque Nm*	Air consumption l/sec	Weight kg	Inlet- thread	Hose diameter mm	Dimensions	
									A mm	B mm
Y-40SA*	1/4" Hex	4-6	10.000	6-12	5.0	0.84	PT 1/4"	6.5	229	17
Y-41A	1/4" Hex	4-6	9.300	6-12	5.0	0.73	PT 1/4"	6.5	141	17
Y-46E	3/8" Square	5-6	8.000	16-30	5.8	0.87	PT 1/4"	9.5	158	18
Y-46A	1/4" Hex	5-6	8.000	16-26	5.8	0.87	PT 1/4"	9.5	158	18
Y-56E	3/8" Square	6-8	7.000	25-47	6.6	0.87	PT 1/4"	9.5	144	21
Y-56A	1/4" Hex	6-8	7.000	22-33	6.6	0.87	PT 1/4"	9.5	144	21
Y-61E	3/8" Square	6-8	5.500	34-54	6.6	0.96	PT 1/4"	9.5	155	21
Y-61A	1/4" Hex	6-8	5.500	27-41	6.6	0.96	PT 1/4"	9.5	155	21
Y-70	3/8" Square	8-10	5.500	44-72	7.5	1.4	PT 1/4"	9.5	170	25
Y-90E	1/2" Square	10-12	5.000	78-116	8.3	1.85	PT 1/4"	9.5	177	30
Y-100E	1/2" Square	12	5.000	100-145	11.8	2.0	PT 1/4"	12.7	188	32.5
Y-130E	1/2" Square	14	3.500	140-220	12.8	2.5	PT 1/4"	12.7	201	34
Y-140	3/4" Square	16	3.300	160-270	13.1	3.2	PT 1/4"	12.7	226	36

* Y-40SA is a straight model, all other types are pistol models.

*** Torque specifications:**

All specified torques are measured on the Yokota testers, series YET, at a dynamic airpressure of 0.59Mpa. The Yokota testers have a static transducer, the specified torques are therefore to be used as a guidance only. In general the torque range will be lower in case of using: lower airpressure, extension bars, torx or hexagon inset sockets, soft joints, etc.



Y-40SA

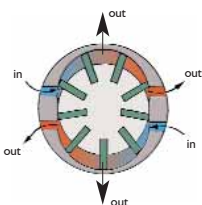

The Yokota Y-series impulse wrenches with double chamber air motor reach the required torque very quickly. The tools have a high number of impulses per second, and therefore very accurate torques can be realised, resulting in increased production speed.

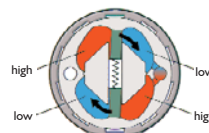

Twin blade impulse unit (torque generating PAT.P) Yokota's unique impulse mechanism reduces noise and vibration! High impulse frequency

Impulse wrenches

Double chamber air motor & shut-off



Type	Square/ Hex drive	Bolt capacity mm	Revolutions p/min	Torque Nm*	Air consumption l/sec	Weight kg	Inlet- thread	Hose diameter mm	Dimensions	
									A mm	B mm
Y-T40A	1/4" Hex	4-5	6.000	8-13	6.0	0.95	PT 1/4"	6.5	182	18.5
Y-T45E	3/8" Square	6	7.000	17-25	5.8	1.10	PT 1/4"	9.5	187	21
Y-T45A	1/4" Hex	6	7.000	15-20	5.8	1.10	PT 1/4"	9.5	187	21
Y-T55E	3/8" Square	6-8	6.000	25-38	5.8	1.12	PT 1/4"	9.5	187	21
Y-T55A	1/4" Hex	6-8	6.000	20-30	5.8	1.12	PT 1/4"	9.5	187	21
Y-T70E	3/8" Square	10	5.500	40-55	6.6	1.50	PT 1/4"	9.5	207	25
Y-T90E	1/2" Square	10-12	5.000	60-90	7.5	1.90	PT 1/4"	9.5	200	31

*** Torque specifications:**

All specified torques are measured on the Yokota testers, series YET, at a dynamic airpressure of 0.59Mpa. The Yokota testers have a static transducer, the specified torques are therefore to be used as a guidance only. In general the torque range will be lower in case of using: lower airpressure, extension bars, torx or hexagon inset sockets, soft joints, etc.

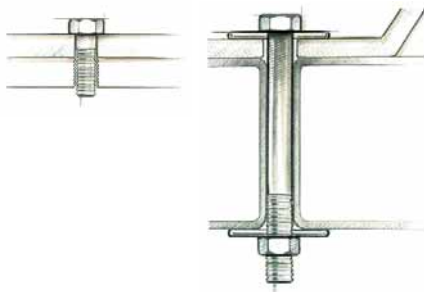

In order to get full benefit of all the advantage of impulse wrenches, it is most important that the correct tool is used for the correct application. Each joint has its own characteristics. Please ask us to help you to select the right tool for your application.

You will find accessories for impulse wrenches on pages 18 - 20.

Rubber protection covers for all Y and Y-T impulse wrenches are included in the box.

Impulse wrenches

Battery impulse wrenches



Type	Square/ Hex Drive	Bolt capacity mm	Revolutions p/min	Torque Nm*	Weight kg	Dimensions	
						A mm	B mm
YBX-50A	1/4" Hex	5-8	2.200	7-22	1.7	194	26
YBX-50E	3/8" Square	5-8	2.200	7-22	1.7	194	26

*** Torque specifications:**

All specified torques are measured on the Yokota testers, series YET, at a dynamic airpressure of 0.59Mpa.
The Yokota testers have a static transducer, the specified torques are therefore to be used as a guidance only.
In general the torque range will be lower in case of using: lower airpressure, extension bars, torx or hexagon inset sockets, soft joints, etc.

One battery is supplied as standard (EB-9G).
On request batteries with LED-indication and chargers 20 or 105 minutes (page 18).
Multiple charger on request.

You will find accessories for battery impulse wrenches on pages 18 - 20.



YBX-50A - left/right switch



YBX-50A - better ergonomics and grip



YBX-50A - Yokota impulse technology



YBX-50A - easy service

Poka Yoke⁺ system

For critical tightening jobs in assembly industry



YLa 90E-J



Y-90E-J

Type	Square/ Hex drive	Bolt capacity mm	Revolutions p/min	Torque Nm*	Air consumption l/sec	Weight kg	Inlet- thread	Hose diameter mm	Dimensions A mm	B mm
Y-41A-J	1/4" Hex	4-6	9.300	6-12	5.0	0.73	PT 1/4"	6.5	141	17
Y-46E-J	3/8" Square	5-6	8.000	16-30	5.8	0.87	PT 1/4"	9.5	158	18
Y-56E-J	3/8" Square	6-8	7.000	25-47	6.6	0.87	PT 1/4"	9.5	144	21
Y-61E-J	3/8" Square	6-8	5.500	34-54	6.6	0.96	PT 1/4"	9.5	155	21
Y-70-J	3/8" Square	8-10	5.500	44-72	7.5	1.4	PT 1/4"	9.5	170	25
Y-90E-J	1/2" Square	10-12	5.000	78-116	8.3	1.85	PT 1/4"	9.5	177	30
Y-100E-J	1/2" Square	12	5.000	100-145	11.8	2.0	PT 1/4"	12.7	188	32.5
Y-130E-J	1/2" Square	14	3.500	140-220	12.8	2.5	PT 1/4"	12.7	201	34
Y-140-J	3/4" Square	16	3.300	160-270	13.1	3.2	PT 1/4"	12.7	226	36

New Lightweight Series

YLa 70 A-J	1/4" Hex	6-8	7.000	20-28	5.5	0.80	PT 1/4"	6.9	132	22
YLa 70 E-J	3/8" Square	6-8	7.000	20-35	5.5	0.80	PT 1/4"	6.5	132	22
YLa 80 E-J	3/8" Square	8	7.000	33-50	5.8	0.90	PT 1/4"	6.5	139	22
YLa 90 E-J	3/8" Square	8-10	6.500	47-70	6.7	1.00	PT 1/4"	9.5	148	24
YLa 110 E-J	1/2" Square	10-12	6.000	65-105	9.6	1.40	PT 1/4"	9.5	164	26

* Torque specifications:

All specified torques are measured on the Yokota testers, series YET, at a dynamic airpressure of 0.59Mpa.
The Yokota testers have a static transducer, the specified torques are therefore to be used as a guidance only.
In general the torque range will be lower in case of using: lower airpressure, extension bars, torx or hexagon inset sockets, soft joints, etc.

System features

- Group control
- Controlled shut-off
- Double tightening detection
- Interlock with assembly line
- Error judgment on trigger release before shut-off

Controller YTC-2

- Power supply: 100 - 240 V AC
- Input: 8
- Relay output: 4
(opening and shutting capacity:
MAX DC-48W, AC-220VA)
- Output for solenoid valve: 1
(DC24V 2W)

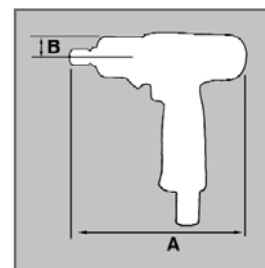

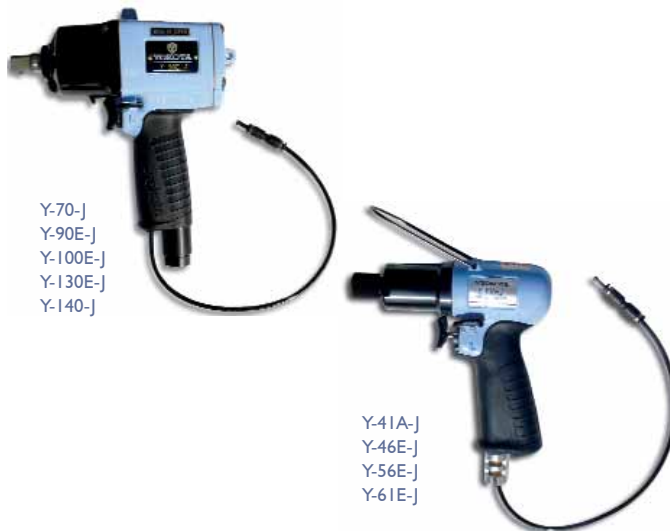

Functioning principle

The system is controlled by measuring the air pressure at the inlet side of the air motor. This air pressure varies from free running to impulsing. By this measured air pressure the controller detects contact of the bolt head (point 2). Upon contact, the adjustable timer gives the shut-off signal (point 3). Adjustability of the timer takes care of adoption to either hard or soft joints. Similar, the controller detects double hits and trigger release before shut-off.

Superior clampforces

In conventional shut-off tools point 2 is the shut-off point. Due to the above mentioned principle of the Poka Yoke⁺ controller, the relaxation is minimized and the correct torque and clampforce are achieved. The torque is adjusted at the impulse mechanism. In combination with the parameters in the controller YTC-2, a reliable shut-off is achieved.

The whole system is more accurate than shut-off or even standard impulse wrenches!

Typical air pressure curve of the impulse wrench

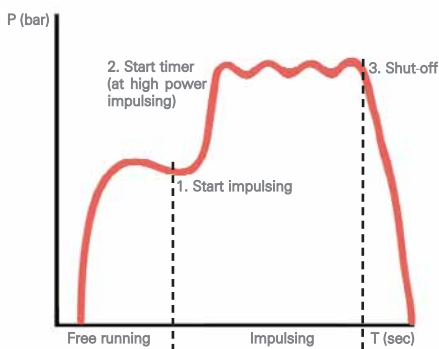

Impulse wrenches

Pistol models



Type	Square/ Hex drive	Bolt capacity mm	Revolutions p/min	Torque Nm*	Air consumption l/sec	Weight kg	Inlet- thread	Hose diameter mm	Dimensions A mm	B mm
YX-180E	3/8" Square	4-6	10.500	19-31	4.2	1.0	PT 1/4"	6	169	23
YX-180A	1/4" Hex	4-6	10.500	18-30	4.2	1.0	PT 1/4"	6	169	23
YX-280E	3/8" Square	6-8	10.500	25-38	5.0	1.02	PT 1/4"	6	180	23
YX-280A	1/4" Hex	6-8	10.500	20-34	5.0	1.02	PT 1/4"	6	180	20
YX-380E	3/8" Square	8	10.000	34-47	5.0	1.24	PT 1/4"	6	180	25
YX-380A	1/4" Hex	6-8	10.000	29-44	5.0	1.24	PT 1/4"	6	180	25.5
YX-500E	3/8" Square	8-10	8.200	31-55	5.8	1.4	PT 1/4"	6	173	26.5
YX-700E	3/8" Square	8-10	8.000	45-78	6.7	1.6	PT 1/4"	9	185	26.5
YX-900E	1/2" Square	10	6.500	70-111	6.7	2.0	PT 1/4"	9	201	30.5
YX-1100E	1/2" Square	10-12	4.700	85-123	7.5	2.2	PT 1/4"	9	210	30.5
YX-1400E	1/2" Square	12-14	6.000	102-148	8.3	2.7	PT 1/4"	9	214	33.5
YX-1900E	1/2" Square	12-14	5.800	140-201	8.3	3.4	PT 1/4"	9	224	35.5
YX-2400E	1/2" Square	14-16	4.200	175-279	9.2	4.1	PT 1/4"	9	236	37.0
YX-3000	3/4" Square	16-18	4.700	200-304	10.0	4.6	PT 1/4"	12.7	246	40.0
YX-4500	3/4" Square	18-20	3.400	392-490	11.6	9.8	PT 3/8"	12.7	300	65.0

* Torque specifications:

All specified torques are measured on the Yokota testers, series YET, at a dynamic airpressure of 0.59Mpa.

The Yokota testers have a static transducer, the specified torques are therefore to be used as a guidance only.

In general the torque range will be lower in case of using: lower airpressure, extension bars, torx or hexagon inset sockets, soft joints, etc.

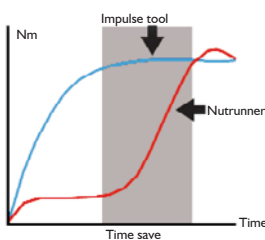

Save time – save money

Because of the principal of using hydraulics to reach a certain torque, impulse tools can run at a high rpm. The required torque is reached in a split second. All Yokota impulse wrenches can be used for hard and soft joints, and give a high accuracy / repeatability and a low relaxation.

Impulse wrenches

Straight / Angle models



YX-180SE/A
YX-280SE/A
YX-380SE/A
YX-500SE
YX-700SE



YX-500C
YX-700C

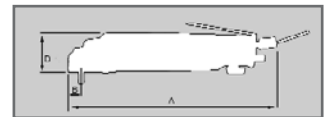
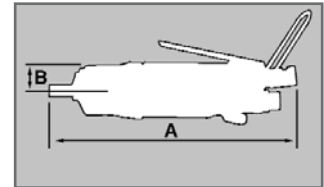

D (YX-500C) = 66mm
D (YX-700C) = 70mm

Type	Square/ Hex drive	Bolt capacity mm	Revolutions p/min	Torque Nm*	Air consumption l/sec	Weight kg	Inlet- thread	Hose diameter mm	Dimensions A B mm mm	
YX-180SE	3/8" Square	4-6	10.500	19-31	4.2	0.96	PT 1/4"	6	220	23
YX-180SA	1/4" Hex	4-6	10.500	18-30	4.2	0.96	PT 1/4"	6	220	23
YX-280SE	3/8" Square	6-8	10.500	25-38	5.0	1.02	PT 1/4"	6	232	23
YX-280SA	1/4" Hex	6	10.500	20-34	5.0	1.02	PT 1/4"	6	232	23
YX-380SE	3/8" Square	8	10.000	32-47	5.0	1.18	PT 1/4"	6	232	25.5
YX-380SA	1/4" Hex	6-8	10.000	29-44	5.0	1.18	PT 1/4"	6	232	25.5
YX-500SE	3/8" Square	8-10	7.500	31-55	5.0	1.25	PT 1/4"	6	241	25.5
YX-700SE	3/8" Square	8-10	5.000	35-62	5.8	1.5	PT 1/4"	9	262	26.5

Angle models

YX-280C	3/8" Square	4-6	10.000	15-24	5.0	1.4	PT 1/4"	6	257	16.0
YX-500C	3/8" Square	6-8	7.500	30-45	5.0	1.5	PT 1/4"	6	266	18.0
YX-700C	3/8" Square	8-10	5.000	36-50	5.8	1.8	PT 1/4"	9	289	18.0

* Torque specifications:

All specified torques are measured on the Yokota testers, series YET, at a dynamic airpressure of 0.59Mpa.
The Yokota testers have a static transducer, the specified torques are therefore to be used as a guidance only.
In general the torque range will be lower in case of using: lower airpressure, extension bars, torx or hexagon inset sockets, soft joints, etc.

For all impulse wrenches quick change couplings - 7/16" hex are available. You can choose out of 2 sizes:
* D09938-0-100 for 3/8" square drive
* D09912-0-100 for 1/2" square drive

You will find accessories for impulse wrenches on pages 18 - 20.

Impulse wrenches

Shut-off



Type	Square/ Hex drive	Bolt capacity mm	Revolutions p/min	Torque Nm*	Air consumption l/sec	Weight kg	Inlet- thread	Hose diameter mm	Dimensions	
									A mm	B mm
YXS-500E	3/8" Square	8-10	8.200	30-50	6.0	1.74	PT 1/4"	6	199	35
YXS-700E	3/8" Square	8-10	8.000	45-70	6.6	1.94	PT 1/4"	9	211	36
YXS-900E	1/2" Square	10	6.500	65-101	6.6	2.45	PT 1/4"	9	227	40
YXS-1100E	1/2" Square	10-12	4.700	80-110	7.5	2.5	PT 1/4"	9	237	40
YXS-1900E	1/2" Square	12-14	5.800	100-160	8.3	3.9	PT 1/4"	9	259	46.5

All YXS impulse wrenches are pistol models.

*** Torque specifications:**

All specified torques are measured on the Yokota testers, series YET, at a dynamic airpressure of 0.59Mpa. The Yokota testers have a static transducer, the specified torques are therefore to be used as a guidance only. In general the torque range will be lower in case of using: lower airpressure, extension bars, torx or hexagon inset sockets, soft joints, etc.

You will find accessories for impulse wrenches on page 18 - 20.

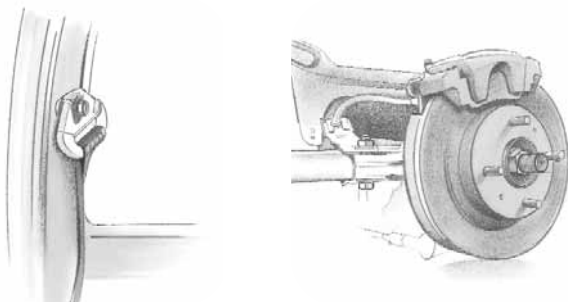

Electronic bolt / torque control

For YEX-, YED- and TKa series



YETC-200

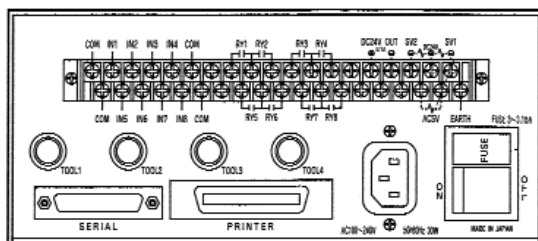
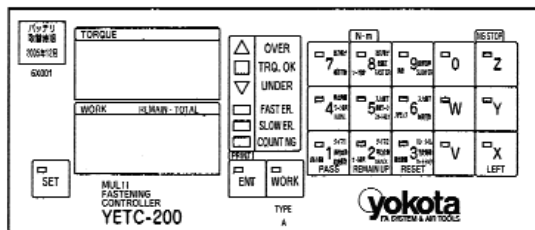

Multi Fastening Controller YETC-200:

The YETC-200 is developed for accurate tightening and fits in a Poka Yoka assembly process. The controller measures, judges, counts and documents all joints and if necessary, files them in a computer. Communication between the controller and the computer increases the number of facilities. One controller can operate four different impulse wrenches with different specifications (like torque adjustments). By programming different groups for each group of joints, the operator can switch tools without notifying the controller. The controller automatically switches to operate the next tool, after tightening all joints within the group according to the specifications. The controller is available in several executions for all kinds of applications and can be programmed in numerous ways, in relation to the various joints.

Features YETC-200 ETB:

- Easy to program, according application specifications
- Improved electronics for even more accurate and faster torque calculations
- Torque calculation over more impulses
- Standard 1 tool connection
- Optional 4 tool connection (not to operate at the same time)
- Compensation impulses to minimize relaxation
- Poka Yoke proof (group control etc.)
- 2-step tightening possible
- Buzzer or LED version tool
- 8 setting groups
- Parallel and RS-232 output for traceability
- External solenoid valves in air supply
- Can be integrated in the production by means of many input- / output signals

Additional features YETC-200 EA:

- 2-way communication by RS-232
- Automatic group change (sequence programmable)
- Real time clock
- Built in timer (for job)
- More input signals (see manual for details)
- More output signals (see manual for details)
- Can be integrated in the production any thinkable way (input - output signals)
- Statistics inside CP CPK
- Memory for 10.000 cycles

Additional features YETC-200 EA - LAN:

- Ethernet (100 BASE-TX/10 BASE-T Autodetect function)
- Protocol: TCP/IP
- Shape of connector: RJ-45

System wrenches

Documentation of the joint

Yokota has impulse wrenches with an integrated transducer (system wrenches). In combination with a controller YETC-200 the torque can be set and judged. The measured torque can be stored in a computer or printed. With this system can be shown that the correct joint was made, in case of product liability claims. The system wrenches only need 1 to 2 seconds for each joint. The tools have no kick back and fit perfectly in a Poka Yoke assembly area.



Straight models
YEX-series (S/SA)



Pistol models
YEX-series

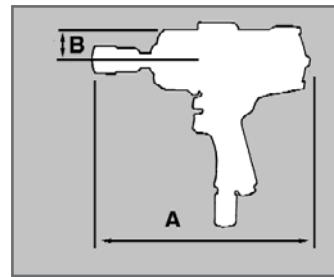
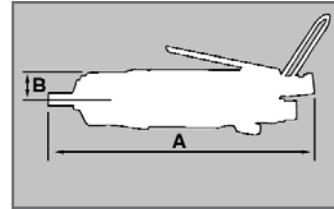

Type	Square/ Hex drive	Bolt capacity mm	Revolutions p/rmin	Torque Nm*	Air consumption l/sec	Weight kg	Inlet- thread	Hose diameter mm	Dimensions	
									A mm	B mm
YEX-100SA	3/8" Hex	5	8.000	4.3 - 12	3.6	1.2	PT 1/4"	9.5	285	23
YEX-120	3/8" Square	4-5	9.000	13-17	4.2	1.43	PT 1/4"	9.5	222	23
YEX-120A	1/4" Hex	4-5	9.000	11-15	4.2	1.43	PT 1/4"	9.5	223	23
YEX-150	3/8" Square	5-6	9.000	19-27	4.2	1.43	PT 1/4"	9.5	222	23
YEX-150A	1/4" Hex	5-6	9.000	14-22	4.2	1.43	PT 1/4"	9.5	223	23
YEX-150S	3/8" Square	5-6	8.000	19-27	4.2	1.35	PT 1/4"	9.5	275	23
YEX-150SA	1/4" Hex	5-6	8.000	14-22	4.2	1.35	PT 1/4"	9.5	276	23
YEX-300S	3/8" Square	6	8.000	25-33	5.0	1.8	PT 1/4"	9.5	312	27
YEX-300SA	1/4" Hex	6	8.000	21-29	5.0	1.8	PT 1/4"	9.5	313	27
YEX-501	3/8" Square	6-8	8.200	25-52	5.3	2.0	PT 1/4"	9.5	234	26.5
YEX-501A	1/4" Hex	6-8	8.200	23-49	5.3	2.0	PT 1/4"	9.5	227	26.5
YEX-500S	3/8" Square	6-8	7.800	23-49	5.0	2.1	PT 1/4"	9.5	333	27
YEX-500SA	1/4" Hex	6-8	7.800	21-47	5.0	2.1	PT 1/4"	9.5	224	27
YEX-700S	3/8" Square	8	7.500	33-61	5.8	2.3	PT 1/4"	9.5	333	27
YEX-701	3/8" Square	8-10	8.000	45-75	6.7	2.2	PT 1/4"	9.5	246	26.5
YEX-901	1/2" Square	10	6.100	61-104	6.7	2.7	PT 1/4"	9.5	257	33.5
YEX-1400	1/2" Square	10-12	5.900	92-142	8.3	3.5	PT 1/4"	9.5	266	34
YEX-1900	1/2" Square	12	5.800	115-183	8.3	4.1	PT 1/4"	9.5	277	39
YEX-3000	3/4" Square	16	4.000	186-284	10.0	6.4	PT 1/4"	12.7	309	40

All YEX-types are pistol models, with exception of the S and SA types.

*** Torque specifications:**

All specified torques are measured on the Yokota testers, series YET, at a dynamic airpressure of 0.59Mpa. The Yokota testers have a static transducer, the specified torques are therefore to be used as a guidance only. In general the torque range will be lower in case of using: lower airpressure, extension bars, torx or hexagon inset sockets, soft joints, etc.

Special hose (type YP YEX) for protection of the signal cable minimizes production stops due to cable damage. Applicable on all YEX pistol models. Standard length: 7m (page 19).

Rubber protection covers for system wrenches are included in the box, with exception of the straight models (page 19).

You will find accessories for system wrenches on pages 18 - 20.

System wrenches

Double chamber air motor

The YED system wrenches are equal to the YEX-series, but with the added feature of a double chamber air motor. The system wrenches with double chamber air motor reach the required torque very quickly. The tools have a high number of impulses per second, and therefore very accurate torques can be realized. On top of that, TKa series have lighter weight, can run on oilfree air and offer best ergonomics. TKa-series can be delivered optionally with LED signalling instead of buzzer.

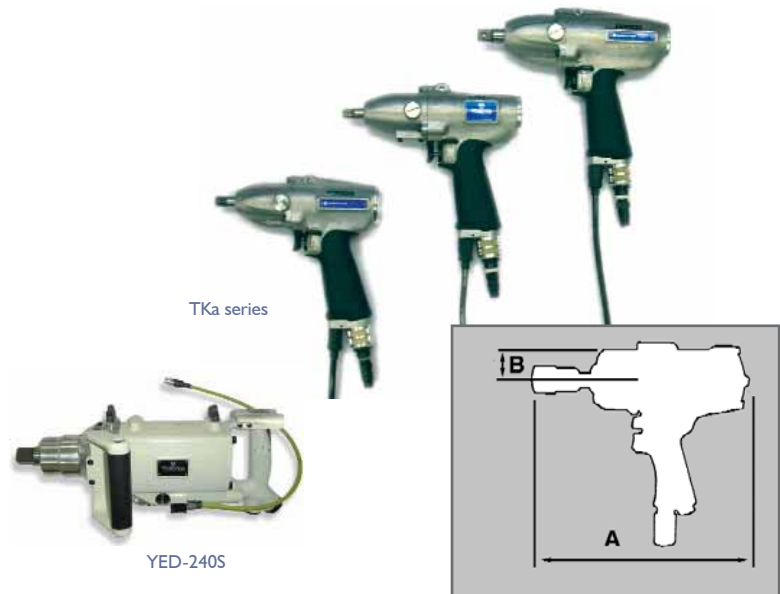

New light weight series

Type	Square/Hex drive	Bolt capacity mm	Revolutions p/min	Torque Nm**	Air consumption l/sec	Weight kg	Inlet-thread	Hose diameter mm	Dimensions	
									A mm	B mm
TKa 70A	1/4" Hex	6-8	7.000	20-27	5.5	1.3	PT 1/4"	6.5	179	22
TKa 70	3/8" Square	6-8	7.000	20-35	5.5	1.3	PT 1/4"	6.5	179	22
TKa 90	3/8" Square	8-10	6.500	47-70	6.7	1.5	PT 1/4"	9.5	195	24
TKa 110	1/2" Square	10-12	6.000	65-105	9.6	1.9	PT 1/4"	9.5	210	26
TKa 120	1/2" Square	12	5.900	85-130	10	2.4	PT 1/4"	9.5	223	28
TKa 140	1/2" Square	14	5.200	100-160	13	2.9	PT 1/4"	9.5	235	30
YED-200	3/4" Square	20	3.400	155-360	18.3	6.8	PT 1/2"	12.7	309	40
YED-240S*	1" Square	24	3.000	250-600	28.3	11.2	PT 1/2"	12.7	452	52.5

* YED-240S is a straight model.

** See torque specifications on page 15



Available as option on TKa System Wrenches:
Integrated LED status-signal

Two colors:
● Green = OK
● Red = not OK

Visible from every angle: left, right, from top and from behind.

For a system YEX, YED or TKa you need:

- 1x controller YETC-200 ETB or YETC-200 A
- 1x impulse wrench YEX, YED or TKa
- 1x solenoid valve and tool cable (7m) YETC-2 SVC

Optional equipment:

- For two-step tightening YETC-2GTB SVD (2 solenoid valves, 2 air pressure regulators and a tool cable 7m)
- Printer YETC-3P and cable YETC-2PC
- Tool cables: YP7642-0908-01-38, connecting cable, YP7642-1400-00-00 (10m), YP7642-0908-01-19 (15m)
- Lamp tower
- Socket selector box
- Spiral hose with intergrated toolcable, max. 15m



The transducer for the YEX, YED and TKa

The strain gauges are positioned on the mainshaft, picking up the twisting torque on the main shaft at each impulse as close as possible to the socket. The electric signals are transmitted by induction through the internal- and external coils. Due to this principle the Yokota transducer is very reliable, accurate and without wear.

System Wrenches

Electric Servo Motor



The Yokota E-wrench has been developed on request of the car industry in order to decrease the cost of production. This has been achieved by decreasing the energy consumption. The energy consumption of the E-wrench is only 10% of the comparable air tool. This benefits as well the environment.

Features

- Better ergonomics due to a lower noise- and vibrationlevel, trigger force and no reaction force
- The E-wrench has a high performance, which results in the same torque accuracy as the YEX/YED (air) system wrench
- High degree of reliability and safety

In comparison with continuous drive tools:

- Time savings up to 35% possible
- At the same torque level: higher clampforces and less relaxation



Type	Square drive	Bolt capacity mm	Rotations p/min	Torque Nm*	Spindle offset mm	Weight kg	Noise level under load dBA
e-M60	3/8"	6	3.500	10 - 25	23	1.9	73
e-M80	3/8"	8	3.500	20 - 40	23	2.6	73

* Torque specifications:

All specified torques are measured on the Yokota testers, series YET, at a dynamic airpressure of 0.59Mpa. The Yokota testers have a static transducer, the specified torques are therefore to be used as a guidance only. In general the torque range will be lower in case of using: lower airpressure, extension bars, torx or hexagon inset sockets, soft joints, etc.

System configuration:

Using AC 100 - 240V as power source. Tightening bolt with torque control function. Torque controller is common with YEX-system air operated wrenches.

Driver unit is required to drive the motor. Controller (YETC-200) and driver unit (e-PDA-2) to be ordered separately.



Accessories

Sleeve Drive Sockets

Action has developed sleeve drive sockets at the request of Yokota to improve the quality of a joint tightening with impulse wrenches. Sleeve Drive Sockets minimize play between socket and tool by reducing "wobble" and stabilizing the torque setting. The use of Sleeve Drive Sockets is not only to the benefit of the actual joint, but also to the benefit of the tool and operator for it reduces vibration, noise level and socket wear.

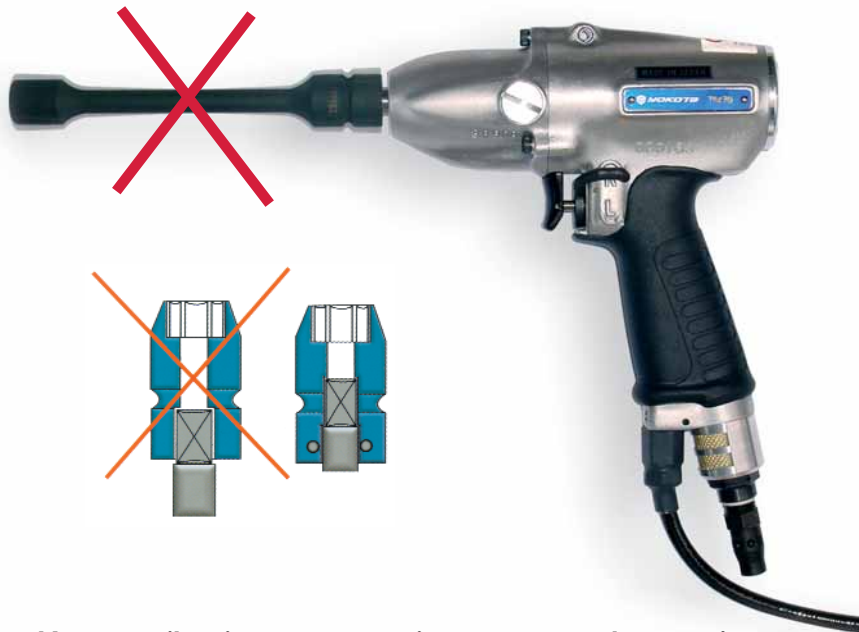

No more vibration, no more noise, no more socket wear!

Please ask for our special brochure on **sleeve drive sockets**.

An overview of the available range:

- Hexagon sockets
- Long or standard size
- Internal and External Torx ®
- Magnetic sockets Hexagon
- Internal Hexagon sockets
- 3/8" 1/2" and 3/4" Square Drive
- extension parts

Technical information

Type	Vibration level m/s ²	Noise level dB(A)
TKa70	2.1	75
TKa90	2.1	78
TKa110	2.2	80
Y-40SA	4.6	69
Y-41	2.1	72
Y-46	1.0	80
Y-56	1.0	80
Y-61	1.0	74
Y-70	2.0	75
Y-90	1.5	72
Y-100	2.1	80
Y-130	2.2	83
Y-140	3.3	82
Y-T40	2.2	82
Y-T45	1.6	74
Y-T55	2.3	75
Y-T70	2.1	82
Y-T90	1.5	85
YBX-50	3	79
YED-200	4.2	86
YED-240S	15	92
YEX-100S	3	77
YEX-120	3	72
YEX-120S	3.3	73
YEX-150	3	72
YEX-150S	3.3	73
YEX-300S	5.3	71
YEX-500S	6.6	71
YEX-501	1.6	68
YEX-700S	6.6	72
YEX-701	1.6	71
YEX-901	2.3	73
YEX-1400	3	80
YEX-1900	3	82
YEX-3000	4	82
YLa70	1.4	74
YLa80	1.2	75
YLa90	1.2	78
YLa110	1.8	81
YX-180	3	72
YX-180S	3.3	73
YX-280	2	70
YX-280C	4	83
YX-280S	4	73
YX-380	2.1	75
YX-380S	3.3	75
YX-500	2	68
YX-500C	10	73
YX-500S	6.6	74
YX-700	2	68
YX-700C	8.6	72
YX-700S	6.6	72
YX-900	2	72
YX-1100	2.5	72
YX-1400	2.6	78
YX-1900	3	79
YX-2400	5.3	77
YX-3000	3.9	80
YX-4500	3.9	87
YXS-500	2	68
YXS-700	1.6	68
YXS-900	2	72
YXS-1100	3	76
YXS-1900	2.4	79

Accessories

For (system) impulse wrenches

Rubber protection cover



Order number	for type
0089-0029-0000	YX-180
0081-0029-0000	YX-280
0086-0029-0000	YX-380
0077-0029-0001	YX-500
0129-0029-0001	YX-700
0237-0029-0001	YX-900
0241-0029-0000	YX-1100
0322-0029-0000	YX-1400
0320-0029-0000	YX-1900
0406-0029-0000	YX-2400
0405-0029-0000	YX-3000
0160-0029-0000	Y-46
0159-0029-0000	Y-56
0158-0029-0000	Y-61
0135-0029-0000	Y-70
0141-0029-0000	Y-90
0164-0029-0000	Y-T45
0164-0029-0000	Y-T55
0166-0029-0000	Y-T70
0167-0029-0000	Y-T90
0283-0029-0000	YEF-45
0284-0029-0000	YEF-55
0281-0029-0000	YEF-70
0282-0029-0000	YEF-90
0093-0029-0000	YEX-120
0093-0029-0000	YEX-150
0260-0029-0000	YEX-501
0143-0029-0000	YEX-701
0261-0029-0000	YEX-901
0323-0029-0000	YEX-1400
0321-0029-0000	YEX-1900
0407-0029-0000	YEX-3000
0270-0029-0000	YED-60
0146-0029-0000	YED-90

Battery for battery impulse wrenches



Order number	For type	Description
8530-3001-00-01	YBX-1/YBX-50	9,6 Volt / 2.0 AH, Type EB-9B
8530-3002-00-00	YBX-1/YBX-50	9,6 Volt / 2.0 AH, Type EB-9M with LED-indication

Chargers for battery impulse wrenches



Order number	For type	Description
8530-4005-00-00	YBX-1/YBX-50	230 Volt, Type UC24YC Charging time 20 minutes

Quick change couplers 7/16"hex



Order number	For type
D09938-0-100	3/8" square drive
D09912-0-100	1/2" square drive

Protection hose



Order number	For type
YP YEX	YEX and YED series

Tool holder



Order number	For type
SKK	YX-180 / YX-500 / YXS-500 / Y-40 / Y-61 / Y-T45 / Y-T55 / YEF-45 / YEF-55 / YEX-120 / YEX-150 / YED-60
SKZ	YX-500S / YX-1400 / YXS-700 / YXS-1100 / Y-70 / Y-90 / Y-130/ Y-T70 / Y-T90 / YEF-70 / YEF-90 / YEX-300 / YEX-1400 / YBX-1

Accessories

For maintenance and service

Service sets

You will need these service sets with spare parts if you are going to change the oil. For quick service we advise you to use a vacuum pump and oil tank (Y EVP-1 + Y EVP-1T).

Note! Always use oil with the right specifications when changing oil. Only then you will have an optimal tool power and a minimum oil consumption. **We recommend VONO BP oil for the impulse unit.**

For type	Order number
YX-180	0089-0991-0099
YX-280	0089-0991-0099
YX-380	0086-0991-0099
YX-500S (C)	0086-0991-0099
YX-500	0077-0991-0099
YX-700 (S)	0129-0991-0099
YX-700C	0281-0991-0099
YX-900	0237-0991-0099
YX-1100	0237-0991-0099
YX-1400	0322-0991-0099
YX-1900	0320-0991-0099
YX-2400	0320-0991-0099
YX-3000	0405-0991-0099
YX-4500	0722-0991-0099
YXS-500	0245-0991-0099
YXS-700	0246-0991-0099
YXS-900	0243-0991-0099
YXS-1100	0243-0991-0099
YXS-1900	0248-0991-0099
TKa-70	0186-0991-0099
TKa-90	0181-0991-0099
TKa-110	0187-0991-0099
YLa-70	0189-0991-0099
YLa-80	0191-0991-0099
YLa-90	0188-0991-0099
YLa-110	0190-0991-0099

Yokota torque measuring equipment (YET-series) is specially designed to check and test the functioning and performance of impulse wrenches. All specified torque figures in this brochure are measured on a Yokota torque tester (YET series), with 0,59 Mpa air pressure (dynamic). This is a static torque tester. Torque figures measured on other testers or tested on different joints (hard/soft) can differ.

Model YET-501C	5 - 50 Nm
Model YET-2001C	20 - 200 Nm
Model YET-5001C	100 - 500 Nm



Service sets containing:

O-rings, back-up rings and springs for impulse mechanisms required for oil change.

For type	Order number
Y-41	0095-0991-0099
Y-46	0273-0991-0099
Y-56	0259-0991-0099
Y-61	0259-0991-0099
Y-70	0135-0991-0099
Y-90	0141-0991-0099
Y-100	0334-0991-00-99
Y-130	0335-0991-00-99
Y-140	0412-0991-01-09
YBX-1	0259-0991-0099
YBX-50	0259-0991-0099
YED-60	0270-0991-0099
YED-70	0175-0991-0199
YED-90	0146-0991-0099
YED-200	0409-0991-0099
YED-240S	0411-0991-0199
YEF-45	0273-0991-0099
YEF-70	0281-0991-0099
YEF-90	0282-0991-0099
YEX-120	0089-0991-0099
YEX-150	0089-0991-0099
YEX-300S	0086-0991-0099
YEX-500S	0077-0991-0099
YEX-501	0077-0991-0099
YEX-700S	0143-0991-0099
YEX-701	0143-0991-0099
YEX-901	0237-0991-0099
YEX-1400	0323-0991-0099
YEX-1900	0320-0991-0099
YEX-3000	0405-0991-0099
Y-T40	0169-0991-0099
Y-T45	0164-0991-0099
Y-T55	0164-0991-0099
Y-T70	0166-0991-0099
Y-T90	0167-0991-0099

